



TRISp

SUSTAV URBANE OPREME

TRISQ – SUSTAV URBANE OPREME
PRODUKT DIZAJN: ADA KEZIĆ
PROIZVOĐAČ: NOTOS d.o.o.

SUSTAV URBANE OPREME „TRISQ” NAMIJENJEN JE PONAJPRIJE OPREMANJU EKSTERIJERA POPUT JAVNIH PARKOVA, GRADSKIH TRGOVA, ŠETNICA, VRTOVA, STAJALIŠTA (AUTOBUSNIH, TRAMVAJSKIH, ŽELJEZNIČKIH), KOLODVOVA TE PRIVATNIH VRTOVA I OKUĆNICA. MOŽE SE PRIMIJENITI I U INTERIJERIMA JAVNIH USTANOVA I OBJEKATA (SHOPPING-CENTRI, ŠKOLE, MUZEJI, GALERIJE, ULAZNI PROSTORI ITO.).

KLUPE S NASLONOM I BEZ NASLONA, KAO I MALE KLUPICE/DRŽAČI BICIKALA ELEMENTI SU OD CJELOVITOG DRVA, OBLIKA SLOVA „L” I OBRNUTO POSTAVLJENOG SLOVA „U”, MEĐUSOBNO POPREČNO UČVRŠĆENIH SISTEMOM OD INOKS-CIJEVI.

ELEMENTI OBLIKA SLOVA „L” MOGU SE POMAKNUTI ULIJEVO ILI UDESNO 32 CM, ODNOSNO 64, 96 I NAJVIŠE 128 CM, ČIME SE DOBIVA VEĆA UPORABNA POVRŠINA KLUPA I DRŽAČA BICIKALA. OSNOVNA JE DULJINA KLUPA 190 CM I MOGU SE PRODUŽITI NA 222, 254, 286 I 318 CM, KLUPICA/DRŽAČ BICIKALA SA 109 CM NA 141 CM.

BUDUĆI DA SE OSNOVNI OBLICI POJAVLJUJU U OBLIKU SLOVA „L” I OBRNUTO POSTAVLJENOG SLOVA „U” TE POSTOJI HORIZONTALNI I VERTIKALNI POMAK JEDNIH I DRUGIH OBLIKA, T.J. ELEMENATA KOJI SU RAZLIČITE DEBLJINE, DOBIVAMO ZANIMLJIVU IGROU RAZLIČITIH POVRŠINA.

OBA SE ELEMENTA PONAVLJAJU KOD OBLIKOVANJA KLUPE I KLUPICE /DRŽAČA ZA BICIKLE, DOK SE OBLIK SLOVA „L” PONAVLJA KOD KOŠEVA ZA SMEĆE, ZAŠTITNE OGRADE ZA STABLA I POSUDA ZA CVIJEĆE. STUPIČI ZA ZAUSTAVLJANJE PROMETA POJEDNOSTAVLJENI SU I OGOLJENI NA OBLIK SLOVA „I”.

FINALNI SE PROIZVOD SASTOJI OD JEDNOSTAVNIH ELEMENATA MAKSIMALNO PRILAGOĐENIH EFIKASNOJ PROIZVODNJI TE SE MINIMALISTIČKIM PRISTUPOM DIZAJNIRANJU PROIZVOĐA NAGLAŠAVA LJEPOTA I TOPLINA DRVA.

PREDVIĐENA JE PRIMJENA VIŠE VRSTA CJELOVITOG DRVA PREMA IZBORU NARUČITELJA:

- SLAVONSKI HRAST (ZEMLJA PODRIJETLA HRVATSKA)
- BOR (ZEMLJA PODRIJETLA HRVATSKA)
- SMREKA, JELA (ZEMLJA PODRIJETLA HRVATSKA)
- ARIŠ (SREDNJA EUROPA)
- TIK (EGZOTA)





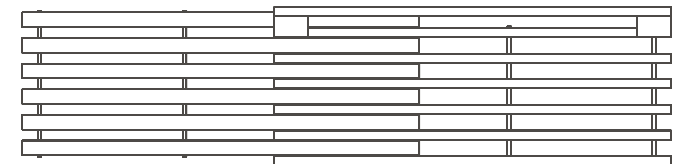
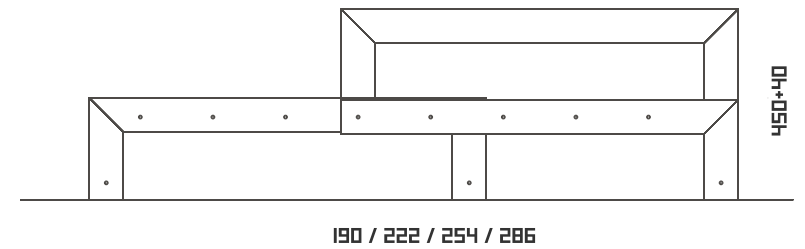
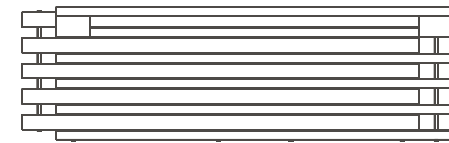
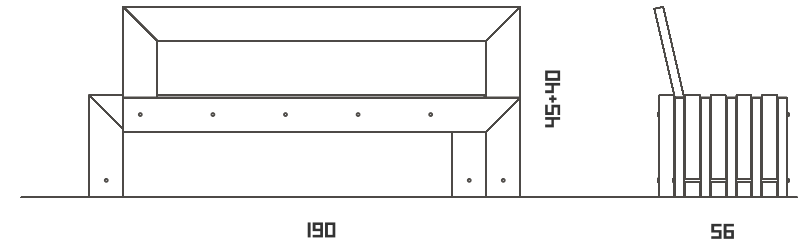

TQ 003

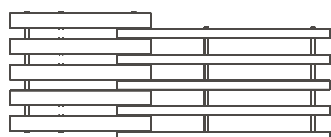
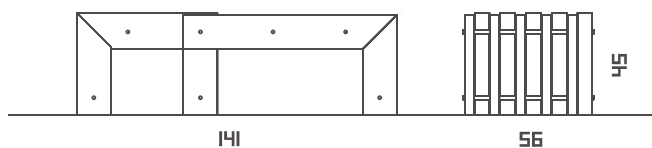
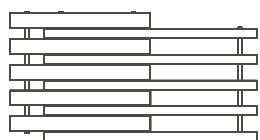
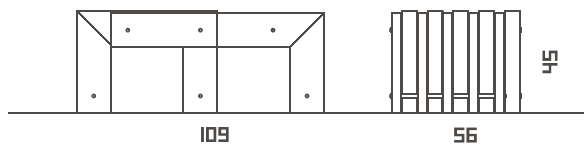





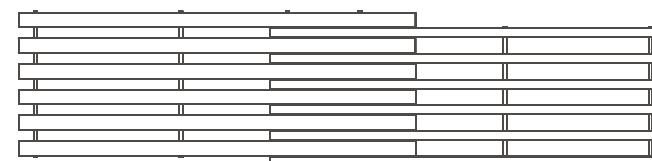
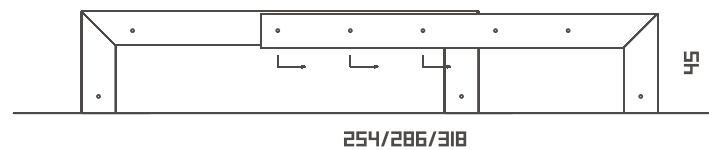
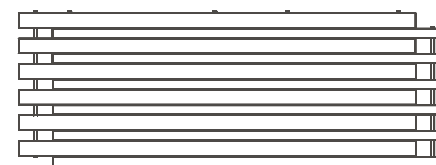
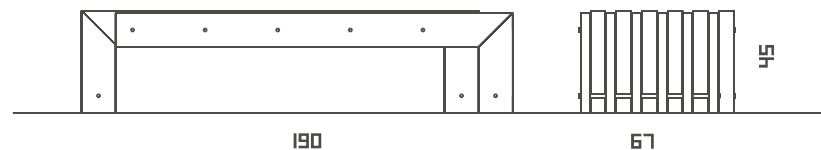

TQ 007 / TQ 001

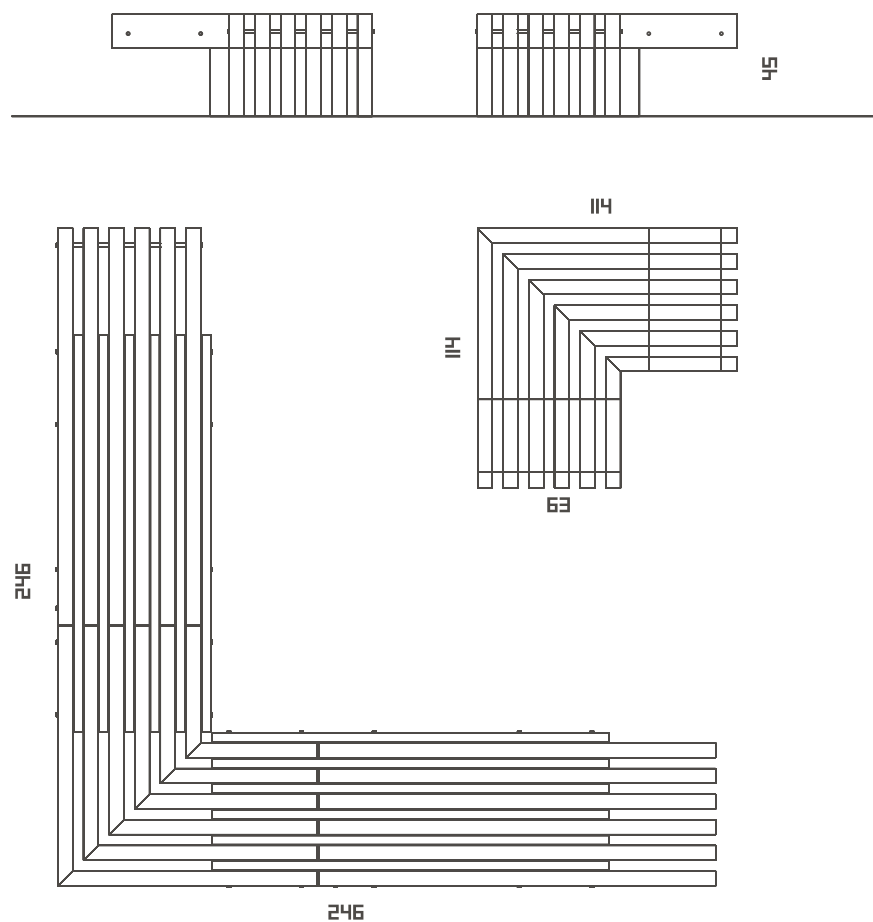



TQ 008 / TQ 009 / TQ 004 / TQ 005

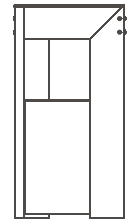
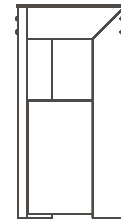
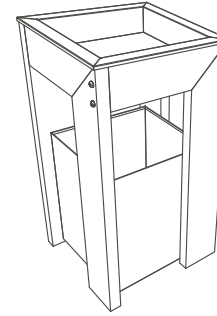

84

48

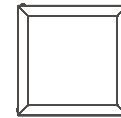

48

48

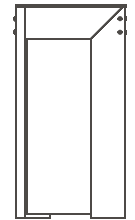
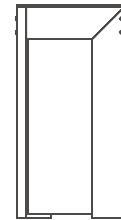
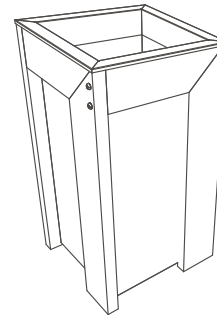

84

48

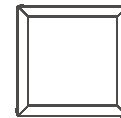

48

48

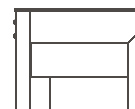
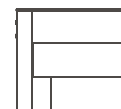
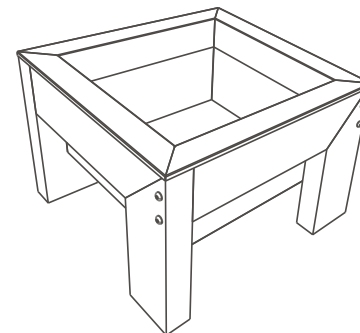

45

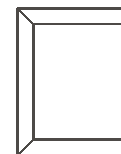

64/87

64/87



Trisa
SUSTAV URBANE OPREME

PRODUKT DIZAJN: ADA KEZIĆ
PROIZVOĐAČ: NOTOS d.o.o.

FOTOGRAFIJA:
DRAŽEN LAPIĆ
ZAŠTITA I DPLEMENJIVANJE DRVA:

WWW.ARP.HR



PRIMARNA PRERADA DRVA:
WWW.PILANA-VRHOVEC.HR



PROIZVODNJA OPREME ZA UGOSTITELJSTVO:
WWW.KLANJCIC.HR





ADA KEZIC

PRODUCT + INTERIOR
DESIGN
+385 1 3455940
+385 95 9021044
WWW.ADAKEZIC.COM

notos 

PROIZVOĐAČ: NOTOS D.O.O. +385 1 3323469 WWW.NOTOS.HR