

NYX.

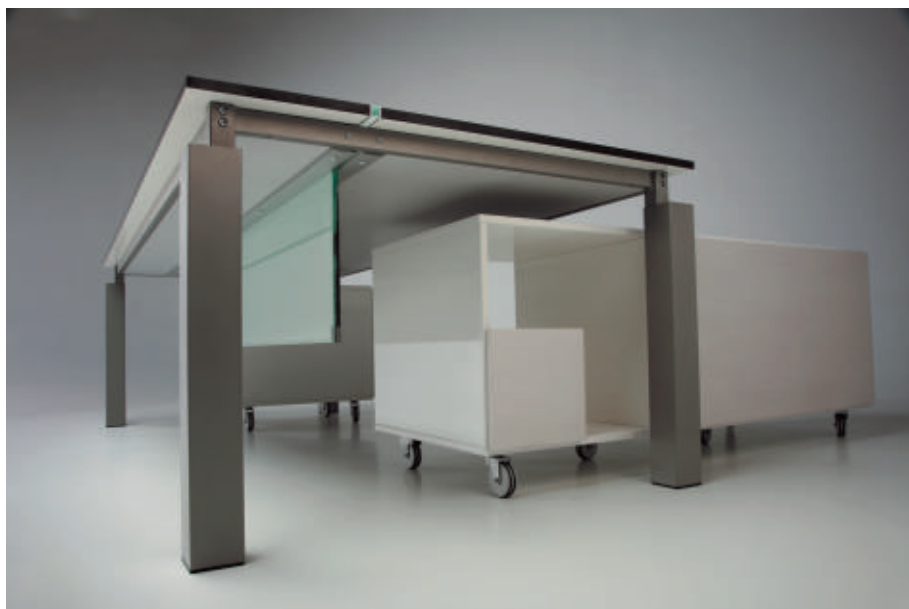

maska stola od kaljenog stakla
debljine 15 mm u boji po izboru



metalna podkonstrukcija s nogama
kvadratnog presjeka 80x80 mm
omogućuje veće dimenzije
menadžerskog stola



radni stol sa staklenom bijelom maskom i pločom od medijapana bijele boje visokog sjaja

prodor za el. instalacije



metalna noga kvadratnog presjeka 80x80 mm



detalj ladice



radni stol s pločom od medijapana
antracit boje visokog sjaja sa
srebrnim metalnim nogama





lagan pristup kućištu računala
i instalacijskim kabelima



komoda antracit boje



komoda na kotačićima s 4 ladice, vratima,
policom i mjestom za kompjutor
dezen - woodline bijeli i bijelo visoki sjaj



prostor za kućište računala,
instalacijske kabele i UPS



ormarić na kotačićima s 4 ladice
dezen - woodline bijeli i bijelo visoki sjaj



konfiguracija radnog stola i komode
na kotačima antracit boje

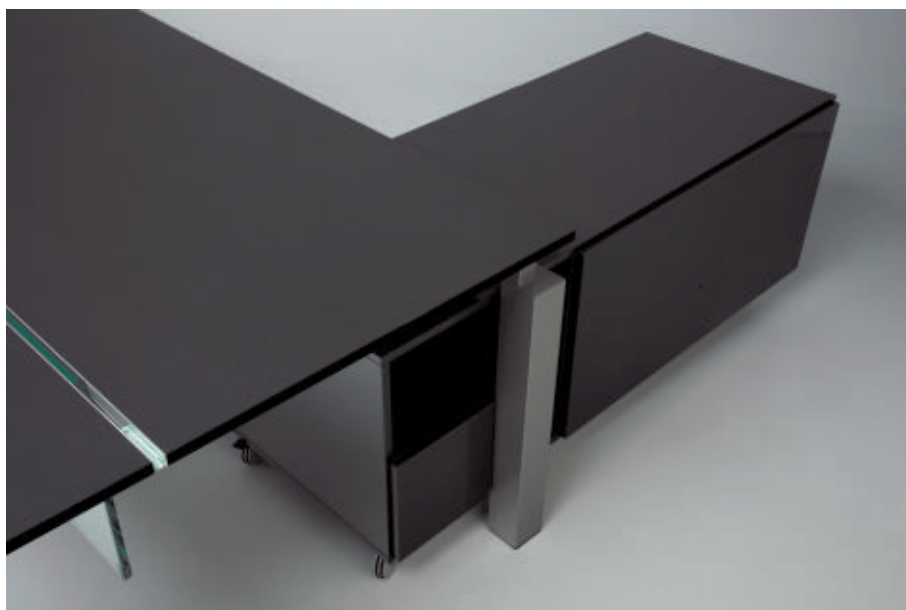



detalj polica



otvoreni ormar s policama
dezen - woodline bijeli



garderobni ormar sa skrivenim vratima
s bočne strane, dezen - woodline bijeli
i bijelo visoki sjaj



dvokrilni ormar za spise
dezen - woodline bijeli i bijelo visoki sjaj





viseći ormar i niska komoda
dezen - zingana







terminal s priključnicama
ugrađen u ploču
konferencijskog stola



ormarić s vratima smješten u središnjem dijelu
stola gdje je predviđen prostor za provođenje
svih instalacijskih kabela i smještaj uređaja za
videokonferencije i prezentacije



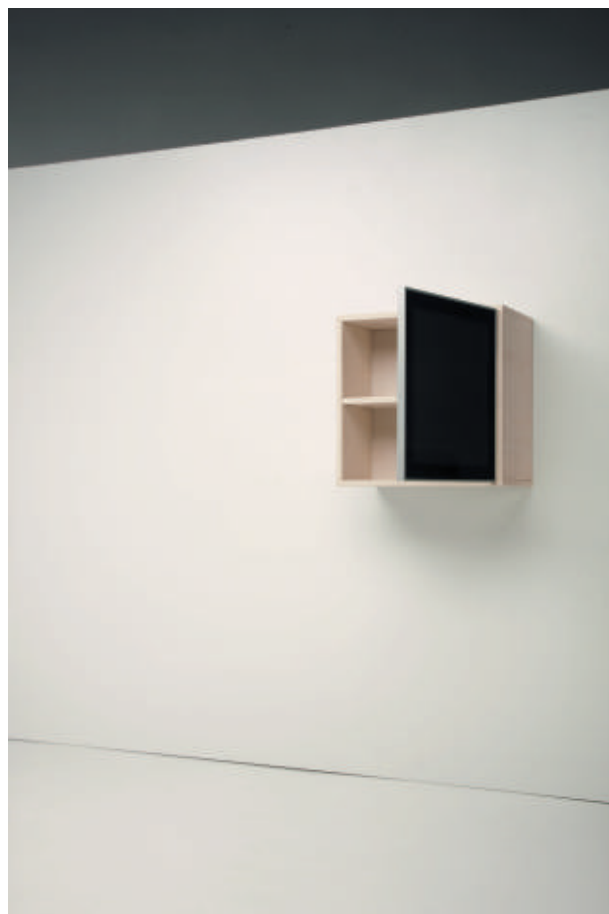

viseći ormarić sa staklenim vratima
u alu okviru, dezen - javor



komoda na kotačičima s 3 duboke
ladice i viseći ormarić, dezen - cedar





niska komoda s ugrađenim
hladnjakom i predviđenim mjestom
za sef s ugrađenom indirektnom
rasvjetom, dezen - medijapan bijele
boje visokog sjaja







viseći ormarići s ugrađenom
LED rasvjetom i staklenim policama,
dezeni - medijapan bijele, antracit i
crne boje visokog sjaja

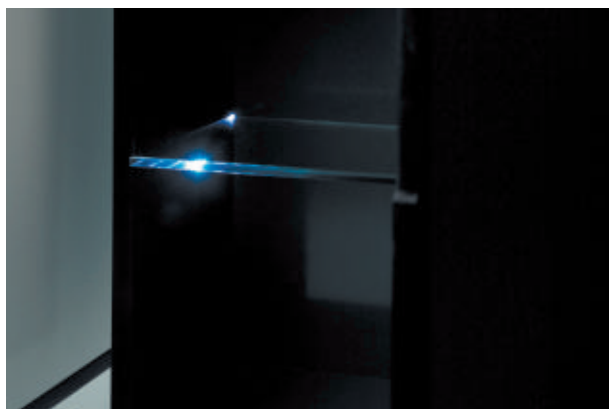



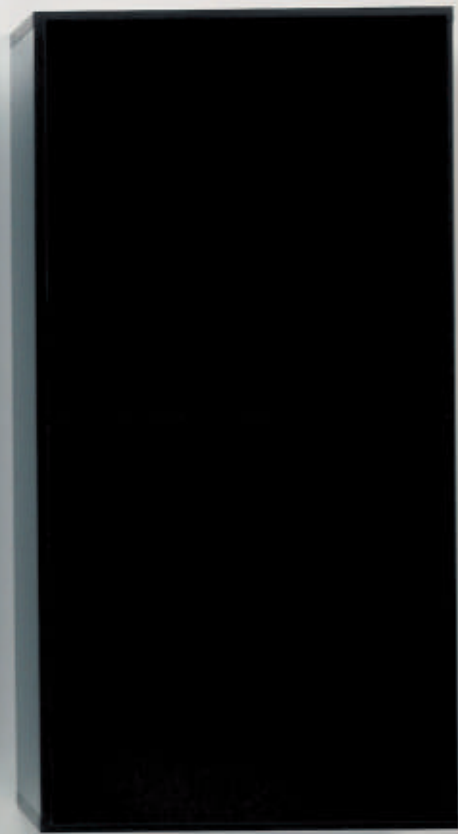

Program uredskog namještaja **NYX**

Dizajn: Ada Kezić, dipl. dizajner
Darko Pavlović, ing. strojarstva
Darko Špiljarić, dipl. ing. arh.

Atest: Šumarski fakultet u Zagrebu
Zavod za namještaj i drvene proizvode
Broj skupnog izvješća 1297 - 07

Proizvodnja: Inkea d.o.o., Branimirova 9, Zagreb

ploča stola i maska stola:
I - iveral
M - MDF visoki sjaj
F - furnir

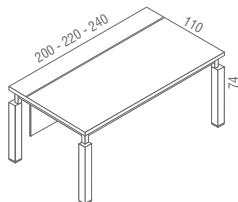

radni stol s metalnim "BLOCK" nogama

RS200-I	Š 200 D 110 V 74
RS220-I	Š 220 D 110 V 74
RS240-I	Š 240 D 110 V 74
RS200-M/F	Š 200 D 110 V 74
RS220-M/F	Š 220 D 110 V 74
RS240-M/F	Š 240 D 110 V 74

Napomena: maska stola u boji po izboru, metalne noge u srebrnoj ili antracit boji

ploča stola:
I - iveral
M - MDF visoki sjaj
F - furnir

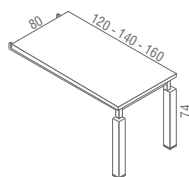

priključni stol s metalnim "BLOCK" nogama

PS120-I	Š 120 D 80 V 74
PS140-I	Š 140 D 80 V 74
PS160-I	Š 160 D 80 V 74
PS120-M/F	Š 120 D 80 V 74
PS140-M/F	Š 140 D 80 V 74
PS160-M/F	Š 160 D 80 V 74

Napomena: metalne noge u srebrnoj ili antracit boji

korpus ormarića - iveral,
fronta, ukrasna leđa i gornja pokrovna ploča:
I - iveral
M - MDF visoki sjaj
F - furnir

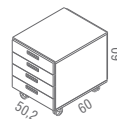

ormarić na kotačićima s 4 ladice

OK4L050-I	Š 50,2 D 60 V 60
OK4L050-M	Š 50,2 D 60 V 60
OK4L050-F	Š 50,2 D 60 V 60

korpus ormarića - iveral,
fronta, ukrasna leđa i gornja pokrovna ploča:
I - iveral
M - MDF visoki sjaj
F - furnir

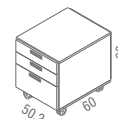

ormarić na kotačićima s 3 ladice

OK3L050-I	Š 50,2 D 60 V 60
OK3L050-M	Š 50,2 D 60 V 60
OK3L050-F	Š 50,2 D 60 V 60

korpus ormarića - iveral,
fronta, ukrasna leđa i gornja pokrovna ploča:
I - iveral
M - MDF visoki sjaj
F - furnir

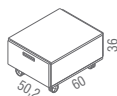

ormarić na kotačićima s 1 ladicom

OK1L050-I	Š 50,2 D 60 V 36
OK1L050-M	Š 50,2 D 60 V 36
OK1L050-F	Š 50,2 D 60 V 36

korpus ormarića - iveral,
fronta, ukrasna leđa i gornja pokrovna ploča:
I - iveral
M - MDF visoki sjaj
F - furnir

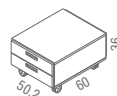

ormarić na kotačićima s 2 ladice

OK2L050-I	Š 50,2 D 60 V 36
OK2L050-M	Š 50,2 D 60 V 36
OK2L050-F	Š 50,2 D 60 V 36

korpus ormarića - iveral,
fronta, ukrasna leđa i gornja pokrovna ploča:
I - iveral
M - MDF visoki sjaj
F - furnir

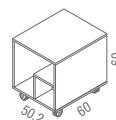

ormarić na kotačićima s mjestom za kompjutor

OKK050-I	Š 50,2 D 60 V 60
OKK050-M	Š 50,2 D 60 V 60
OKK050-F	Š 50,2 D 60 V 60

L/D

korpus ormarića - iveral,
fronta, ukrasna leđa i gornja pokrovna ploča:
I - iveral
M - MDF visoki sjaj
F - furnir

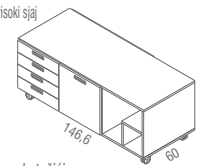

komoda na kotačićima s 4 ladice, policama, 1 vratima i mjestom za kompjutor

OK4LWK-I	Š 146,6 D 60 V 60
OK4LWK-M	Š 146,6 D 60 V 60
OK4LWK-F	Š 146,6 D 60 V 60

L/D

korpus ormarića - iveral,
fronta, ukrasna leđa i gornja pokrovna ploča:
I - iveral
M - MDF visoki sjaj
F - furnir

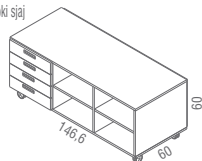

komoda na kotačićima s 4 ladice i policama

OK4L4P-I	Š 146,6 D 60 V 60
OK4L4P-M	Š 146,6 D 60 V 60
OK4L4P-F	Š 146,6 D 60 V 60

L/D

korpus ormarića - iveral,
fronta, ukrasna leđa i gornja pokrovna ploča:
I - iveral
M - MDF visoki sjaj
F - furnir

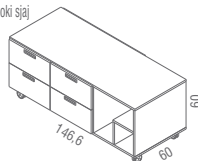

komoda na kotačićima s 4 duboke ladice i mjestom za kompjutor

OK4LD-I	Š 146,6 D 60 V 60
OK4LD-M	Š 146,6 D 60 V 60
OK4LD-F	Š 146,6 D 60 V 60

L/D

korpus ormarića - iveral,
fronta, ukrasna leđa i gornja pokrovna ploča:
I - iveral
M - MDF visoki sjaj
F - furnir

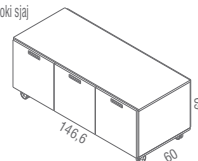

komoda na kotačićima s policama i 3 vratima

OK3V6P-I	Š 146,6 D 60 V 60
OK3V6P-M	Š 146,6 D 60 V 60
OK3V6P-F	Š 146,6 D 60 V 60

korpus ormarića - iveral,
fronta, ukrasna leđa i gornja pokrovna ploča:
I - iveral
M - MDF visoki sjaj
F - furnir

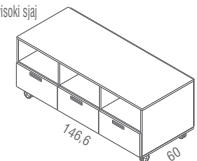

komoda na kotačićima s policama i 3 duboke ladice

OK3L3P-I	Š 146,6 D 60 V 60
OK3L3P-M	Š 146,6 D 60 V 60
OK3L3P-F	Š 146,6 D 60 V 60

korpus ormara - iveral
vrata i gornja pokrovna ploča:
I - iveral
M - MDF visoki sjaj
F - furnir

L/D

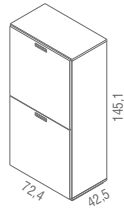

ormar s 2 vratima

O2V073-I	Š 72,4 D 42,5 V 145,1
O2V073-M	Š 72,4 D 42,5 V 145,1
O2V073-F	Š 72,4 D 42,5 V 145,1

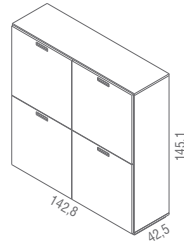

ormar s 4 vratima

O4V143-I	Š 142,8 D 42,5 V 145,1
O4V143-M	Š 142,8 D 42,5 V 145,1
O4V143-F	Š 142,8 D 42,5 V 145,1

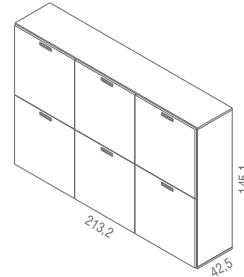

ormar s 6 vratima

O6V213-I	Š 213,2 D 42,5 V 145,1
O6V213-M	Š 213,2 D 42,5 V 145,1
O6V213-F	Š 213,2 D 42,5 V 145,1

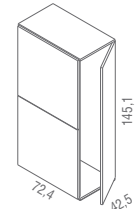

garderobni ormar

G01V073-I	Š 72,4 D 42,5 V 145,1
G01V073-M	Š 72,4 D 42,5 V 145,1
G01V073-F	Š 72,4 D 42,5 V 145,1

police, srednjica i leđa ormara - iveral
gornja pokrovna ploča, dno i bokovi ormara:
I - iveral
M - MDF visoki sjaj
F - furnir

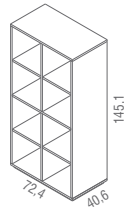

otvoreni ormar

O0073-I	Š 72,4 D 40,6 V 145,1
O0073-M	Š 72,4 D 40,6 V 145,1
O0073-F	Š 72,4 D 40,6 V 145,1

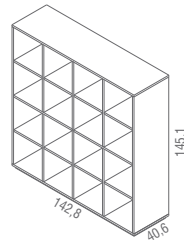

otvoreni ormar

O0143-I	Š 142,8 D 40,6 V 145,1
O0143-M	Š 142,8 D 40,6 V 145,1
O0143-F	Š 142,8 D 40,6 V 145,1

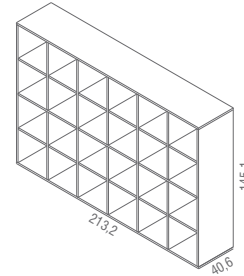

otvoreni ormar

O0213-I	Š 213,2 D 40,6 V 145,1
O0213-M	Š 213,2 D 40,6 V 145,1
O0213-F	Š 213,2 D 40,6 V 145,1

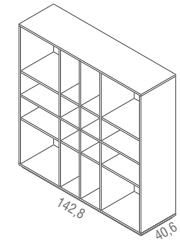

otvoreni ormar

O0X143-I	Š 142,8 D 40,6 V 145,1
O0X143-M	Š 142,8 D 40,6 V 145,1
O0X143-F	Š 142,8 D 40,6 V 145,1

korpus ormara - iveral
vrata i gornja pokrovna ploča:
I - iveral
M - MDF visoki sjaj
F - furnir

L/D

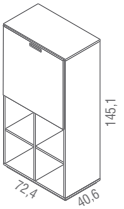

ormar s 1 vratima i otvorenim dijelom

O01V073-I	Š 72,4 D 42,5 V 145,1
O01V073-M	Š 72,4 D 42,5 V 145,1
O01V073-F	Š 72,4 D 42,5 V 145,1

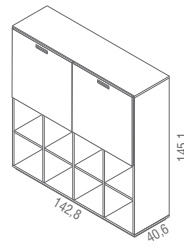

ormar s 2 vratima i otvorenim dijelom

O02V143-I	Š 142,8 D 42,5 V 145,1
O02V143-M	Š 142,8 D 42,5 V 145,1
O02V143-F	Š 142,8 D 42,5 V 145,1

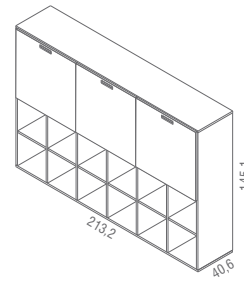

ormar s 3 vratima i otvorenim dijelom

O03V213-I	Š 213,2 D 42,5 V 145,1
O03V213-M	Š 213,2 D 42,5 V 145,1
O03V213-F	Š 213,2 D 42,5 V 145,1

ukrasna leđa ormara:
I - iveral
M - MDF visoki sjaj
F - furnir

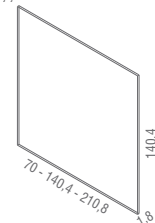

ukrasna leđa ormara

IL07/14/21	Š 70/140,4/210,8 V 140,4
ML07/14/21	Š 70/140,4/210,8 V 140,4
FL07/14/21	Š 70/140,4/210,8 V 140,4

korpus visećeg ormara - iveral,
vrata visećeg ormara i gornja pokrovna ploča:
I - iveral
M - MDF visoki sjaj
F - furnir

L/D

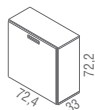

viseći ormar s 1 vratima

V0072-I	Š 72,4 D 33 V 72,2
V0072-M	Š 72,4 D 33 V 72,2
V0072-F	Š 72,4 D 33 V 72,2

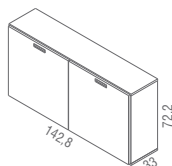

viseći ormar s 2 vratima

V0143-I	Š 142,8 D 33 V 72,2
V0143-M	Š 142,8 D 33 V 72,2
V0143-F	Š 142,8 D 33 V 72,2

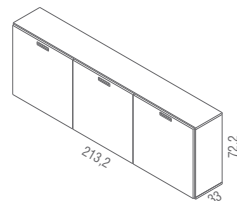

viseći ormar s 3 vratima

V0213-I	Š 213,2 D 33 V 72,2
V0213-M	Š 213,2 D 33 V 72,2
V0213-F	Š 213,2 D 33 V 72,2

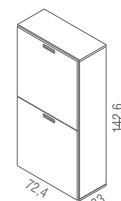

viseći vertikalni ormar s 2 vratima

V0V72-I	Š 72,4 D 33 V 142,6
V0V72-M	Š 72,4 D 33 V 142,6
V0V72-F	Š 72,4 D 33 V 142,6

L/D

korpus visećeg ormarića - iveral,
vrata visećeg ormarića:
I - iveral
M - MDF visoki sjaj
F - furnir

L/D

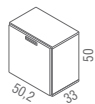

viseći ormar s 1 vratima

V0050-I	Š 50,2 D 33 V 50
V0050-M	Š 50,2 D 33 V 50
V0050-F	Š 50,2 D 33 V 50

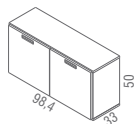

viseći ormar s 2 vratima

V0098-I	Š 98,4 D 33 V 50
V0098-M	Š 98,4 D 33 V 50
V0098-F	Š 98,4 D 33 V 50

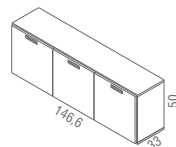

viseći ormar s 3 vratima

V0147-I	Š 146,6 D 33 V 50
V0147-M	Š 146,6 D 33 V 50
V0147-F	Š 146,6 D 33 V 50



viseći vertikalni ormar s 2 vratima

VV098-I	Š 50,2 D 33 V 98,2
VV098-M	Š 50,2 D 33 V 98,2
VV098-F	Š 50,2 D 33 V 98,2

L/D

vrata visećeg ormarića:
AS - staklo u alu okviru
AFS - staklo sa zaštitnom folijom u alu okviru
korpus visećeg ormarića:
I - iveral
M - MDF visoki sjaj
F - furnir

L/D

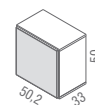

viseći ormar s 1 staklenim vratima u alu okviru

V0050-IAS	Š 50,2 D 33 V 50
V0050-IAFS	Š 50,2 D 33 V 50
V0050-MAFS	Š 50,2 D 33 V 50
V0050-FAFS	Š 50,2 D 33 V 50

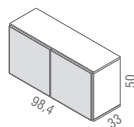

viseći ormar s 2 staklenim vratima u alu okviru

V0098-AS	Š 98,4 D 33 V 50
V0098-AFS	Š 98,4 D 33 V 50
V0098-MAFS	Š 98,4 D 33 V 50
V0098-FAFS	Š 98,4 D 33 V 50

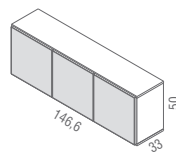

viseći ormar s 3 staklenim vratima u alu okviru

V0147-AS	Š 146,6 D 33 V 50
V0147-AFS	Š 146,6 D 33 V 50
V0147-MAFS	Š 146,6 D 33 V 50
V0147-FAFS	Š 146,6 D 33 V 50

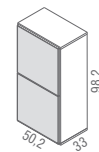

viseći vertikalni ormar s 2 staklenim vratima u alu okviru

VV098-AS	Š 50,2 D 33 V 98,2
VV098-AFS	Š 50,2 D 33 V 98,2
VV098-MAFS	Š 50,2 D 33 V 98,2
VV098-FAFS	Š 50,2 D 33 V 98,2

L/D

korpus visećeg ormarića - iveral,
vrata visećeg ormarića:
I - iveral
M - MDF visoki sjaj
F - furnir

L/D

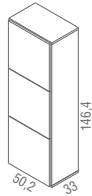

viseći vertikalni ormarić s 3 vratima

VV146-I	Š 50,2 D 33 V 146,4
VV146-M	Š 50,2 D 33 V 146,4
VV146-F	Š 50,2 D 33 V 146,4

vrata visećeg ormarića:
AS - staklo u alu okviru
AFS - staklo sa zaštitnom folijom u alu okviru
korpus visećeg ormarića:
I - iveral
M - MDF visoki sjaj
F - furnir

L/D

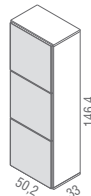

viseći vertikalni ormarić s 3 staklenim vratima u alu okviru

VV146-AS	Š 50,2 D 33 V 146,4
VV146-AFS	Š 50,2 D 33 V 146,4
VV146-MAFS	Š 50,2 D 33 V 146,4
VV146-FAFS	Š 50,2 D 33 V 146,4

korpus visećeg ormarića:
I - iveral
M - MDF visoki sjaj
F - furnir

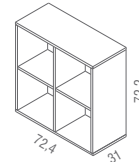

viseći otvoreni ormar

V00072-I	Š 72,4 D 31 V 72,2
V00072-M	Š 72,4 D 31 V 72,2
V00072-F	Š 72,4 D 31 V 72,2

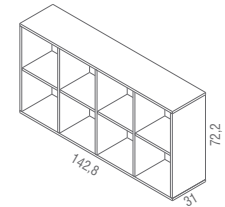

viseći otvoreni ormar

V00143-I	Š 142,8 D 31 V 72,2
V00143-M	Š 142,8 D 31 V 72,2
V00143-F	Š 142,8 D 31 V 72,2

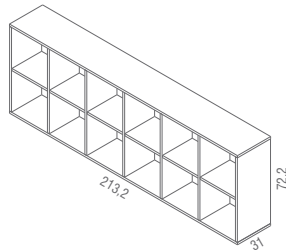

viseći otvoreni ormar

V00213-I	Š 213,2 D 31 V 72,2
V00213-M	Š 213,2 D 31 V 72,2
V00213-F	Š 213,2 D 31 V 72,2

korpus niske komode - iveral,
vrata i gornja pokrovna ploča niske komode:
I - iveral
M - MDF visoki sjaj
F - furnir

L/D

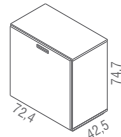

komoda niska s 1 vratima

K1V072-I	Š 72,4 D 42,5 V 74,7
K1V072-M	Š 72,4 D 42,5 V 74,7
K1V072-F	Š 72,4 D 42,5 V 74,7

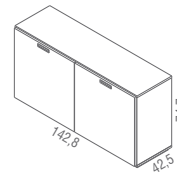

komoda niska s 2 vratima

K2V143-I	Š 142,8 D 42,5 V 74,7
K2V143-M	Š 142,8 D 42,5 V 74,7
K2V143-F	Š 142,8 D 42,5 V 74,7

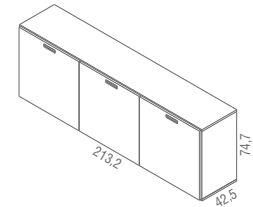

komoda niska s 3 vratima

K3V213-I	Š 213,2 D 42,5 V 74,7
K3V213-M	Š 213,2 D 42,5 V 74,7
K3V213-F	Š 213,2 D 42,5 V 74,7

korpus niske komode - iveral,
vrata i gornja pokrovna ploča niske komode:
I - iveral
M - MDF visoki sjaj
F - furnir

L/D

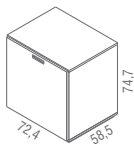

komoda niska duboka s 1 vratima

KD072-I	Š 72,4 D 58,5 V 74,7
KD072-M	Š 72,4 D 58,5 V 74,7
KD072-F	Š 72,4 D 58,5 V 74,7

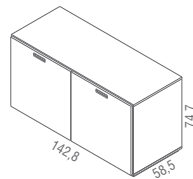

komoda niska duboka s 2 vratima

KD143-I	Š 142,8 D 58,5 V 74,7
KD143-M	Š 142,8 D 58,5 V 74,7
KD143-F	Š 142,8 D 58,5 V 74,7

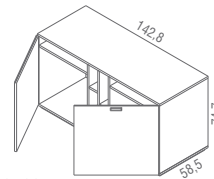

komoda niska duboka s 2 vratima s ugrađenim hladnjakom i setom

KHS143-I	Š 142,8 D 58,5 V 74,7
KHS143-M	Š 142,8 D 58,5 V 74,7
KHS143-F	Š 142,8 D 58,5 V 74,7

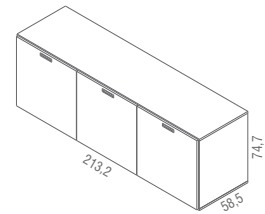

komoda niska duboka s 3 vratima

KD213-I	Š 213,2 D 58,5 V 74,7
KD213-M	Š 213,2 D 58,5 V 74,7
KD213-F	Š 213,2 D 58,5 V 74,7

radna ploča stola:
I - iveral
M - MDF visoki sjaj
F - furnir

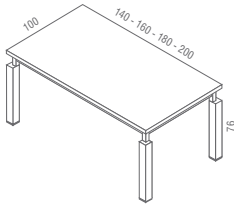

radna ploča stola:
I - iveral
M - MDF visoki sjaj
F - furnir

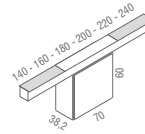
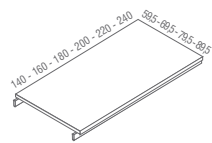

završni stol na metalnim "BLOCK" nogama

ZS140-I	Š 140 D 100 V 74-75,3
ZS160-I	Š 160 D 100 V 74-75,3
ZKS160-I	Š 160 D 160 V 74-75,3
ZS180-I	Š 180 D 100 V 74-75,3
ZS200-I	Š 200 D 100 V 74-75,3
ZS140-F	Š 140 D 100 V 74-75,3
ZS160-F	Š 160 D 100 V 74-75,3
ZKS160-F	Š 160 D 160 V 74-75,3
ZS180-F	Š 180 D 100 V 74-75,3
ZS200-F	Š 200 D 100 V 74-75,3

Napomena: metalne noge u srebrnoj ili antracit boji

spojna ploča stola s podkonstrukcijom

SP140-I	Š 140 D 100 V 6,5-7,8
SP160-I	Š 160 D 100 V 6,5-7,8
SP180-I	Š 180 D 100 V 6,5-7,8
SP200-I	Š 200 D 100 V 6,5-7,8
SP220-I	Š 220 D 100 V 6,5-7,8
SP240-I	Š 240 D 100 V 6,5-7,8
SP140-F	Š 140 D 100 V 6,5-7,8
SP160-F	Š 160 D 100 V 6,5-7,8
SP180-F	Š 180 D 100 V 6,5-7,8
SP200-F	Š 200 D 100 V 6,5-7,8
SP220-F	Š 220 D 100 V 6,5-7,8
SP240-F	Š 240 D 100 V 6,5-7,8

terminal s modulima i ormaničem ispod stola za instalacijske kabele i uređaje

TER2MOD	terminal s 2 modula
TER4MOD	terminal s 4 modula
TER6MOD	terminal s 6 modula
TER8MOD	terminal s 8 modula

Napomena: u terminale se ugrađuju priključnice VGA, audio, LAN, 220 V i dr.

SISTEM SLAGANJA KONFERENCIJSKIH STOLOVA

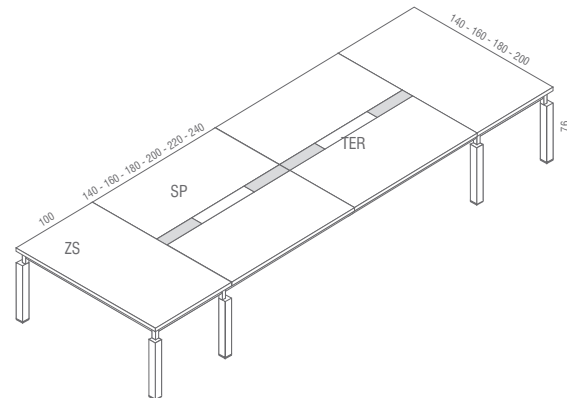
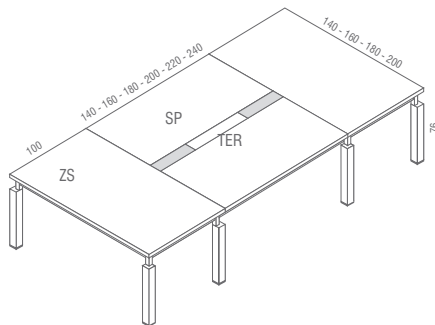
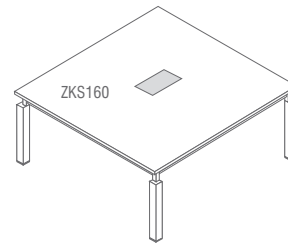



woodline bijeli

bijelo visoki sjaj / mat



javor

antracit



cedar

bijelo visoki sjaj / mat

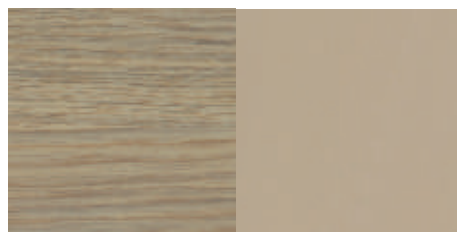

hrast chateau

capuccino

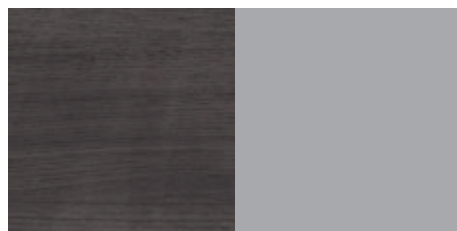

hrast milano

srebrno visoki sjaj / mat

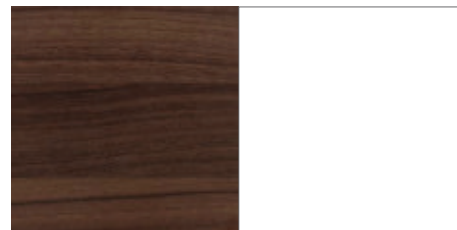

hrast rovere

bijelo visoki sjaj / mat

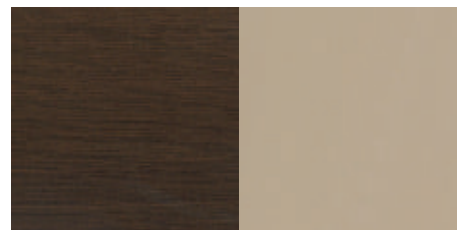

hrast amazona

capuccino

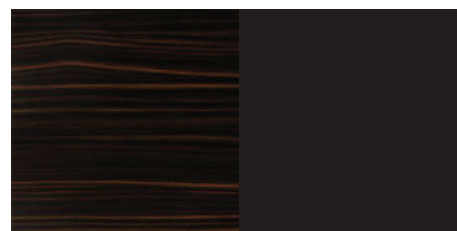

zingana

crno visoki sjaj / mat

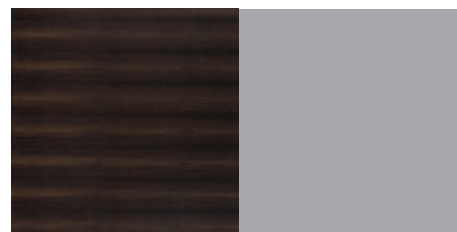

furnir - wenge

srebrno visoki sjaj / mat



furnir - europski javor

antracit

inkea ■

Branimirova 9

10000 ZAGREB

H R V A T S K A

tel ++385 1 4841111

fax ++385 1 4841364

inkea@inkea.hr

www.inkea.hr